

MINI Full HD 1080 Media Center



Model No: MINI1080P

(Please read this operation manual carefully and keep it for daily use)

Index

1.	Function and features.....	2
2.	List of accessories	3
3.	Indications of the player.....	3
4.	Description of remote controller.....	4
5.	Connect to other devices.....	6
	5.1 Connect to PC	6
	5.2 Connect to display devices.....	7
6.	Display mode.....	9
7.	Operation reference.....	10
	8.1 Operation setup menu.....	10
	8.2 Play mode select interface.....	11
	8.2.1 Video interface.....	11
	8.2.2 Music interface.....	13
	8.2.3 Photo interface.....	14
	8.3 Copy and delete functions.....	16
8.	Specifications.....	17

HD 1080P MEDIA PLAYER

Functions and Features

AS a multifunction HD media player, compact and easy, it will become a good companion for both your office work and home entertainment.

1. USB storage: build in NAND flash enables it as a USB 2.0 storage. With optional 2GB/4GB/8GB capacity, it can easily connect to any USB HOST port, no external power supply needed. Compatible with both Windows and MAC OS.
2. USB HOST: can drive external USB storage devices such as USB HDD or USB pen drive, and play or manage files on them.
3. SD/SDHC reader: Directly read SD/SDHC card, and play or manage files on it.
4. Video decoding formats: RM, RMVB, AVI, DIVX, MKV, MOV, HDMOV, MP4, M4V, PMP, AVC, FLV, VOB, MPG, DAT, MPEG, TS, TP, M2TS, WMV, H.264,H.263,WMV9/VC-1,MPEG1/2/4
Video definition:1920x1080x60P
Bitrate: up to 80Mbps
5. Audio types: MP3, WMA, OGG, AAC, FLAC, APE, AC3, DTS, ATRA.
6. Photo: JPEG, TIF, PNG, BMP.
7. Optional functions : With enhanced hardware of DDR and Win CE embedded 6.0 OS,can play flash .SWF and MS office file(Office 2003),.PDF and other OS
Supported formats;
USB keyboard/mouse;
With USB WiFi dongle,LAN streaming/IE browser is enabled;
8. Resume play function: auto play from the break point.
9. File management: can manage the files in devices connected to, manage delete or copy between each others.
10. Support Repeat, Zoom, FF, BF, Rotate functions.
11. Support HDMI, CVBS, YPbPr video output.
12. Stereo L/R, S/PDIF optical(optional) audio output.
13. Dimension (net): 63*60*13 mm.

Note:

All the information contained in this manual was correct at the time of publication. However, as our engineers are always updating and improving the product, your device's software may have a slightly different appearance or modified functionality than presented in this manual.

HD 1080P MEDIA PLAYER

List of accessories

- Remote controller 1PCS
- User Manual(sheet) 1PCS
- AC/DC Power adapter 5V2A 1PCS
- AV cable 1PCS
- USB male-male adapter 1PCS
- HDMI cable (optional) 1PCS
- Separate IR receiver (optional)

Note:

The actual contents in the package might be different from the packing list in this manual.

Interfaces:



HD 1080P MEDIA PLAYER

Description of remote controller



HD 1080P MEDIA PLAYER

Function of remote key table			
POWER	Power Standby	MODE	Change video output mode
ROTATE	Photo rotate	FUNC	Special Function
ZOOM	Picture zoom in/out	MENU	Setting menu
EXIT	Return	OK	Confirm
VOL+/-	Volume up/down	▲ ▼ ▶ ◀	Up, Down, Right, Left
▶▶ ◀◀	Fast forward/backward	▶▶ ◀◀	Skip to next/previous
■	Stop	▶	Play/Pause

HD 1080P MEDIA PLAYER

Connect to other devices

*Connect to PC

Use the USB connector to connect the USB interface of your player and USB interface of a PC. Your player now becomes USB storage device. You can store your downloads and other files. (Refer to picture below)

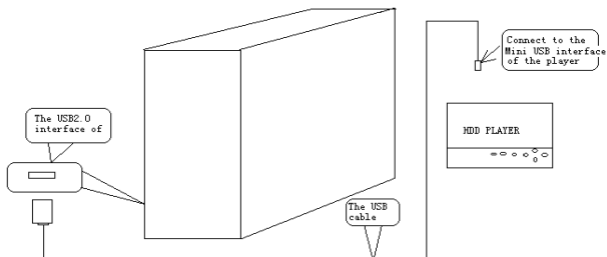

(Note:

1. No need to plug in AC/DC adapter
2. This product can work with the following OS: Windows XP, Windows Me, Windows 2000 etc.

HD 1080P MEDIA PLAYER

***Connect to display devices**

1. AV interface to TV

Use the AV cable to connect player with TV through AV interface.
(Refer to picture below)

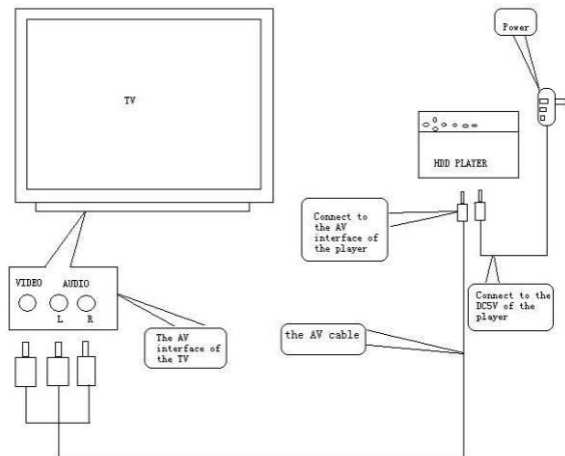

HD 1080P MEDIA PLAYER

2. YPbPr interface to TV

Use the YPbPr cable to connect player with TV through the YPbPr interface, and use the AV cable to connect the AV interface of the player with the TV audio interface (red, white). (Refer to picture below)

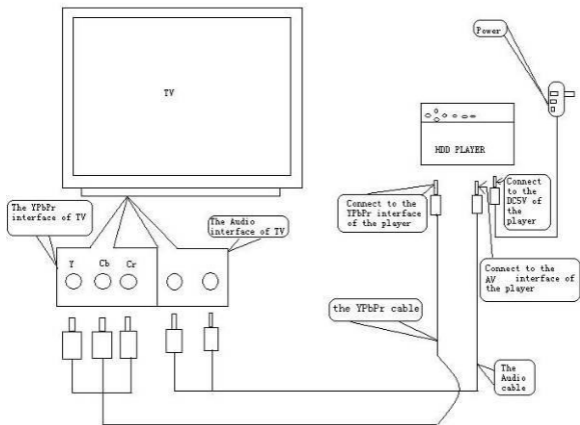

3. HDMI interface to TV

Use the HDMI cable to connect the player with a HDTV. (Refer to picture below)

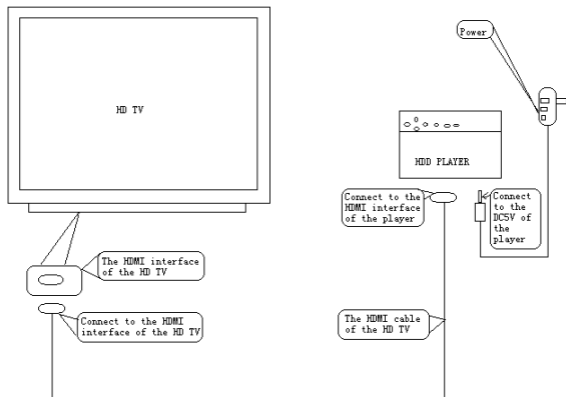

Display mode

1. Set up TV display mode.
2. Set up the player output mode as same as TV by remoter (MODE key to switch between AV, YPbPr, HDMI).

Eg: the default display mode is AV output mode, if you want to change to HMDI display mode, firstly to set up the TV as HDMI output, then press the MODE KEY of player's remoter, until the TV display normally.

HD 1080P MEDIA PLAYER

Operation reference

After power on, it will enter into the main menu. (Refer to picture1)



Picture1

Operation setup menu

1. Select the setting option by pressing the LEFT/RIGHT key in main menu, then press the ENTER key to confirm. (Refer to picture2, picture3)

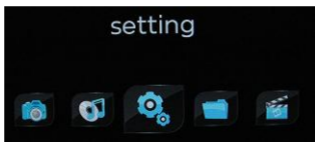

Picture2

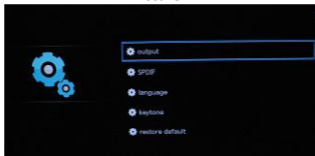

Picture3

Output: Set up the output mode: NTSC, PAL, YPbPr, HDMI modes.

SPDIF: ON or OFF selection for optical output.

Language: Set up different languages. Such as: S-Chinese, English, T-Chinese.

HD 1080P MEDIA PLAYER

Keytone: ON or OFF selection for keytone.

Restore default: Restore the factory setting.

Play mode select interface

****Video interface***

1. Select the movie option by pressing the LEFT/RIGHT key in main menu, then press the ENTER key to enter into the video interface. (Refer to picture4)
2. Select the device from which you prefer to play the movie, press ENTER key to confirm, please refer to picture5.



Picture4

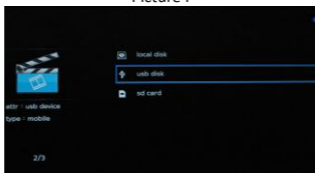

Picture5

3. Press UP or DOWN key to choose the movie, and press the ENTER key to confirm. (Refer to picture6)

HD 1080P MEDIA PLAYER



Picture6

Remark: operation while playing the movie: [Refer to remote controller]

- “▶▶” : In full screen playing status, press this key will fast forward play the current file. Press the ENTER key will return to normal playing speed.
- “◀◀” : In full screen playing status, press this key will fast backward play the current file. Press the ENTER key will return to normal playing speed.
- “VOL” : In full screen playing status, press the VOL+ or VOL- key to increase or decrease the volume.
- “◀◀” : Press this key to play the previous movie.
- “▶▶” : Press this key to play the next movie.
- “⏸” : In full screen playing status, press this key will to pause the video, press again to continue the current playing file.
- “■” : Press this key to stop playing.

4. In the condition of playing movie, press FUNCTION key will enter into the submenu of playing. (Refer to picture7)





Picture7

- “←” : Back to superior menu.
- “🔊” : Choose the audio track.
- “A” : Show the subtitle list.
- “⏸” : Choose the screen display mode.

HD 1080P MEDIA PLAYER

“”: Choose the play sequence “only once, rotate one, rotate all, sequence, random”.

“”: Choose the audio channel output “stereo, left channel, right channel”.

“”: Choose the text color of subtitle “default (white), red, blue”.

Note: 1. In the menu, if has “✓” record, means has been selected already. Press ENTER key to confirm, the EXIT key to return back to the previous menu.

2. Exit from a video with power on, and enter again into the same video, the system will ask you if to continue from last break point.

****Music interface***

1. Select the music option by pressing the LEFT/ RIGHT key in main menu interface, then press the ENTER key to enter into the music list. (Refer to picture8)

2. In the list of “music”, select the device from which you prefer to play the music, press the ENTER key to confirm, please refer to the picture9.

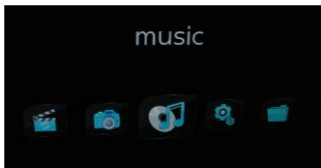

Picture8

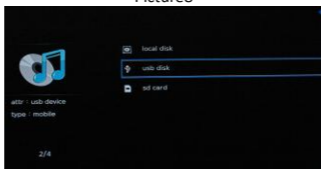

Picture9

HD 1080P MEDIA PLAYER

3. Press UP/ DOWN key to choose the music, and press the ENTER key to confirm.
(Refer to picture10)

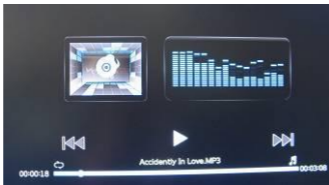

Picture10

Remark: some operation when playing the music: [Refer to remote]

“▶▶” : In full screen playing status, press this key will fast forward play the current file. Press the ENTER key will return to normal playing speed.

“◀◀” : In full screen playing status, press this key will fast backward play the current file. Press the ENTER key will return to normal playing speed.

“VOL” : In full screen playing status, press the VOL+ or VOL- key to increase or decrease the volume.

“◀◀” : Press this key to play the previous music.

“▶▶” : Press this key to play the next music.

“▶||” : In full screen playing status, press this key to pause the audio, and press again to continue the current playing file.

“■” : Press this key to stop playing.

4. In the condition of playing music, press FUNCTION key will enter into the submenu of playing. (Refer to picture11)



Picture11

HD 1080P MEDIA PLAYER

“”: Back to superior menu.

“”: Choose the play sequence “only once, rotate one, rotate all, sequence, random”.

“”: Choose the EQ mode “nature, DBB, pop, rock, classic, jazz, vocal, soft”.

“”: Choose the display for Spectrum or Lyric. .

“”: Choose the text color for Lyric “blue, red, yellow, green, orange”.

****Photo interface***

1. Select the picture option by pressing the LEFT/ RIGHT key in main menu interface, then press ENTER key to enter into the picture list. (Refer to picture 12)
2. In the list of “picture”, select the device from which you prefer to enjoy the photo, press ENTER key to confirm. (Refer to picture13)

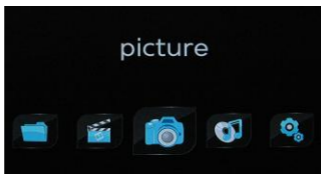

Picture12

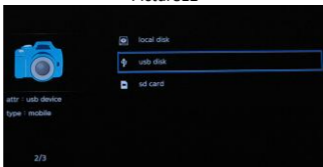

Picture13

3. Press UP or DOWN key to choose the photo to play, and press ENTER to confirm.

Remark: operation for showing the photo: [Refer to remote]

“”press this key to play the previous photo

“”press this key to play the next photo

HD 1080P MEDIA PLAYER

In the condition of playing picture, press FUNCTION key to enter into the submenu.
(Refer to picture 14)





Picture 14

Press LEFT/RIGHT key to choose functions, and press ENTER to confirm:

“” : Back to superior menu.

“” : Pause the slide show.

“” : Press the ENTER key, you can find the function list for Zoom in, Zoom out, Rotate, UP, DOWN etc.

“” : Show picture list.

“” : Choose the play mode for pictures.

“” : Choose the slide show time “1s, 3s, 10s”.

“” : Choose the sequence for picture play.

Copy/Delete functions

1. Select the explore option by pressing the LEFT/ RIGHT key in root menu interface, then press the ENTER key to select a folder or a file, press  key will show the instruction of sort, copy, delete and paste options. Please refer to picture15&picture16, use the LEFT/ RIGHT key to select the appointed function. Or press the RIGHT key will show the copy, delete and paste function as picture17 showed.

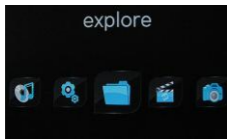

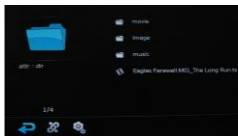

Picture15



Picture16

HD 1080P MEDIA PLAYER

“”: Back to superior menu.

“”: Sort the file.

“”: Copy, Paste, Delete the folder/file. (Refer to picture17)



Picture17

Specifications

Power Supply	DC 5.0V/2A
Power Consumption	≤800mA
Video System	CVBS(PAL/NTSC), YPbPr(720P), HDMI(1080P)
Dimensions	63*60*13mm
Weight(net/packaged)	50g/220g
Video format	RM, RMVB, AVI, DIVX, MKV, MOV, HDMOV, MP4, M4V, PMP, AVC, FLV, VOB, MPG, DAT, MPEG, TS, TP, M2TS, WMV (H.264, H.263, WMV9/VC-1, MPEG1/2/4)
Audio format	MP3, WMA, OGG, AAC, FLAC, APE, AC3, DTS, ATRAC
Photo format	BMP, JPG, PNG, GIF
E-book	TXT
Video Output	1Vp-p+/- (75 Ohm)
Audio Output	2.0Vrms+/- 0.3V

HD 1080P MEDIA PLAYER

Audio Signal Output Characteristics	Frequency Response	20Hz-22kHz
	SNR	> 90dB(1kHz 0dB)
	Dynamic Scope	> 80dB(1kHz 0dB)
	THD	< 0.04%
	Crosstalk	> 80dB(1kHz 0dB)
Support Devices	Internal Flash , USB storage, SD/SDHC card	
Remote Controller	Infrared,distance:7m,angle:30degree, 3.0V cell battery	